

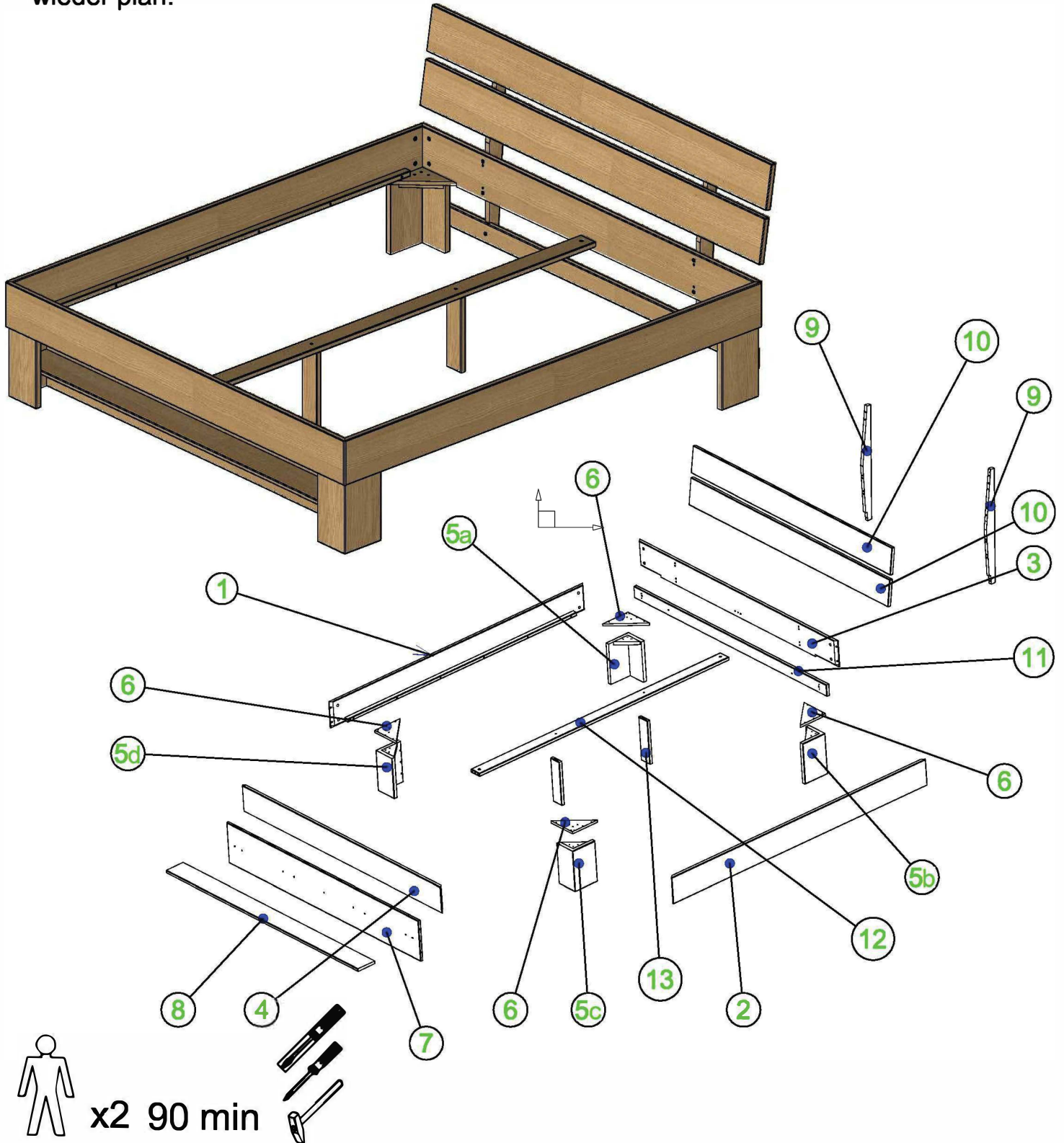









ERBACH / SOFIE 140

versionsnummer:

05.2018



Naturholz kann sich werkstoffbedingt verziehen. Durch das Montieren ziehen sich Teile wieder plan.

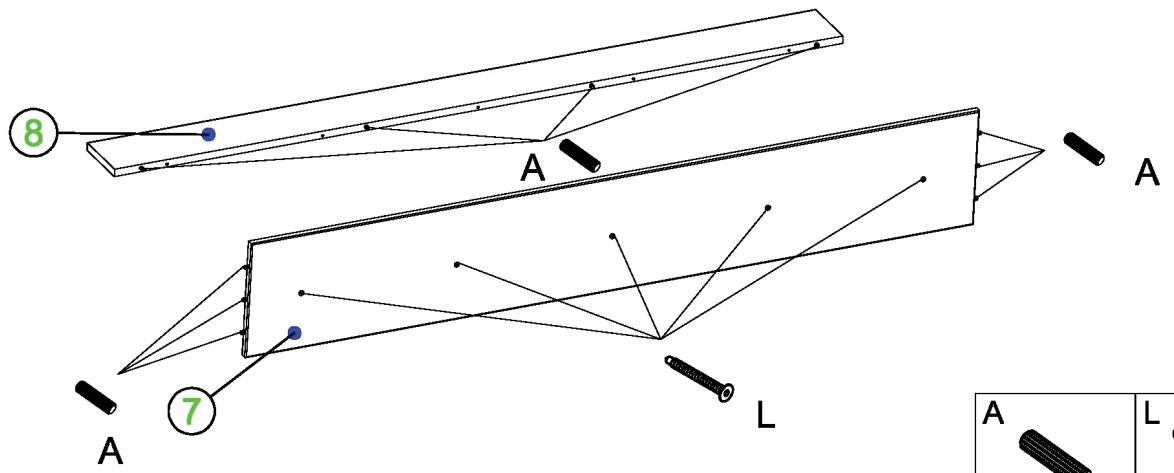

| | | | | | | | | |
|---|---|--|---|---|--|--|---|--|
| A  Ø 8x30 32 | B  18 | D  2 | D1  8 | G  Ø 4x30 40 | H  Ø 4x40 8 | L  Ø 7x50 7 | N  M6x40 6 | S  1 |
|---|---|--|---|---|--|--|---|--|



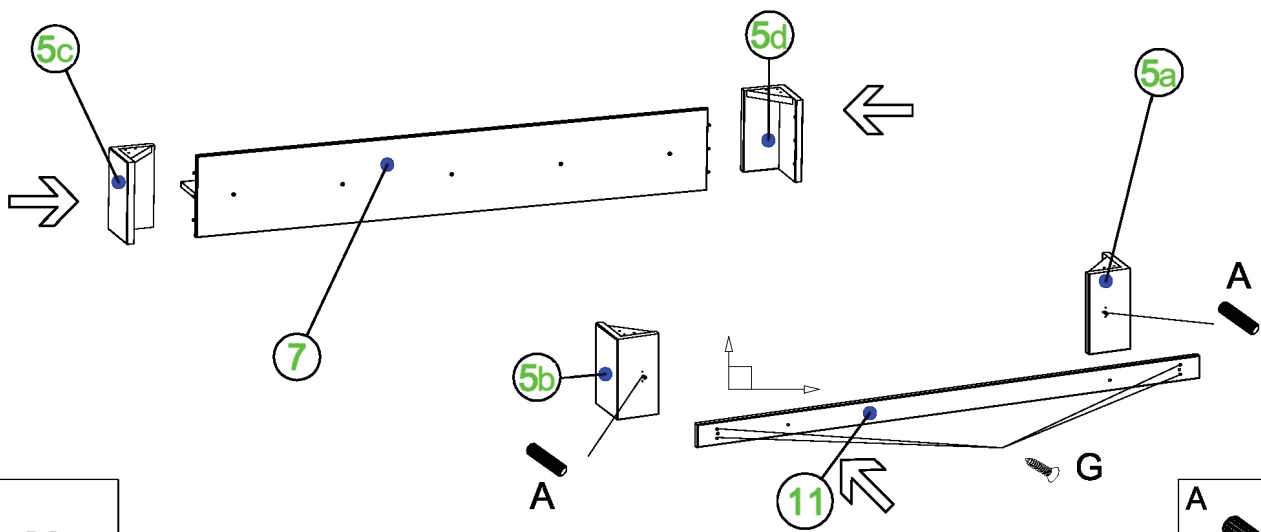

I

| | |
|---|---|
| A | L |
|  |  |
| Ø 8x30 10 | Ø 7x50 5 |





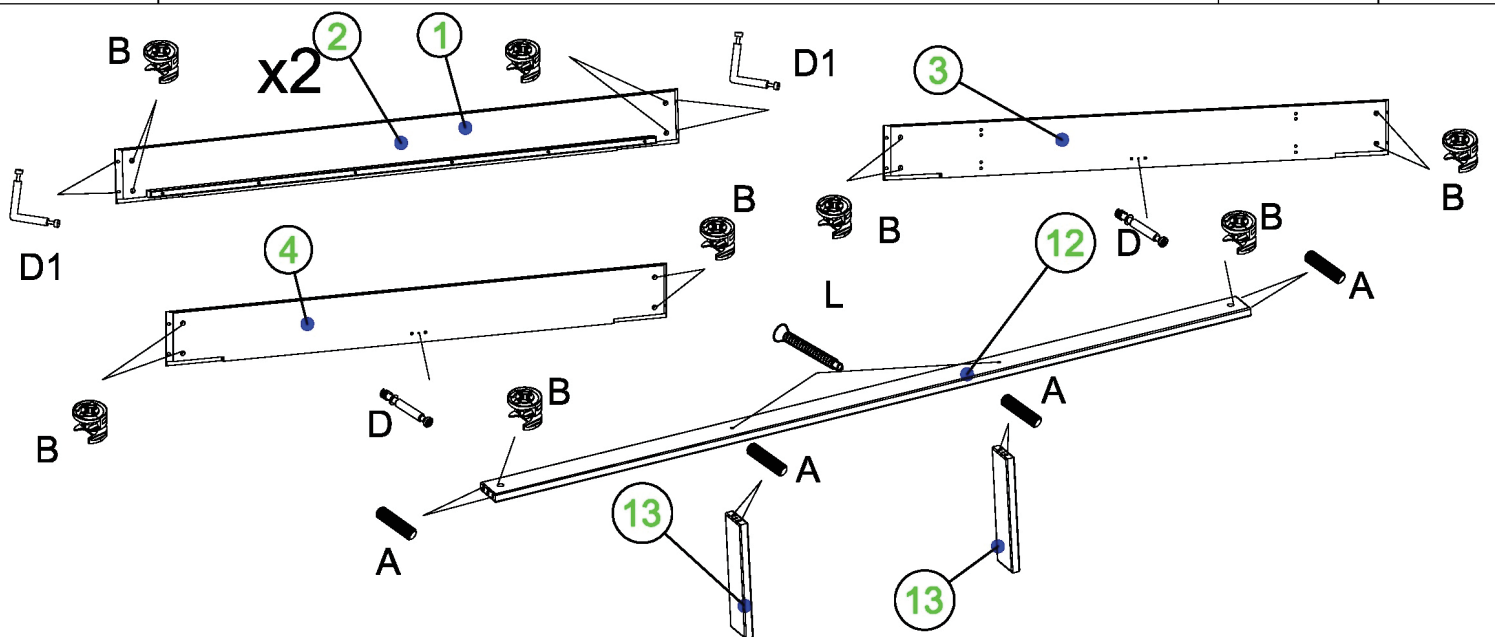

II

| | |
|---|---|
| A | G |
|  |  |
| Ø 8x30 2 | Ø 8x30 4 |



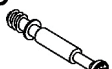

III

| | | | | |
|---|--|---|---|---|
| A | B | D | D1 | L |
|  |  |  |  |  |
| Ø 8x30 8 | 18 | 2 | 8 | Ø 7x50 2 |

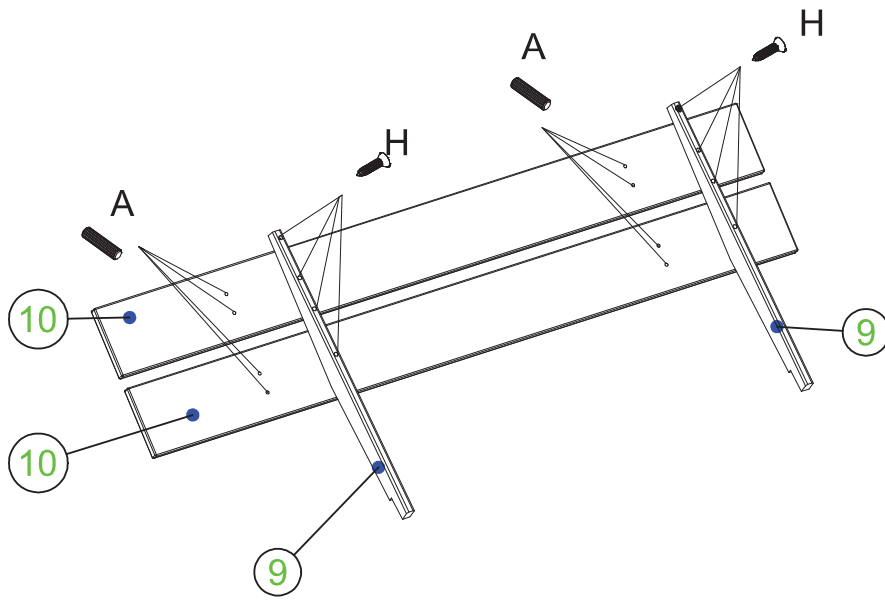

VII

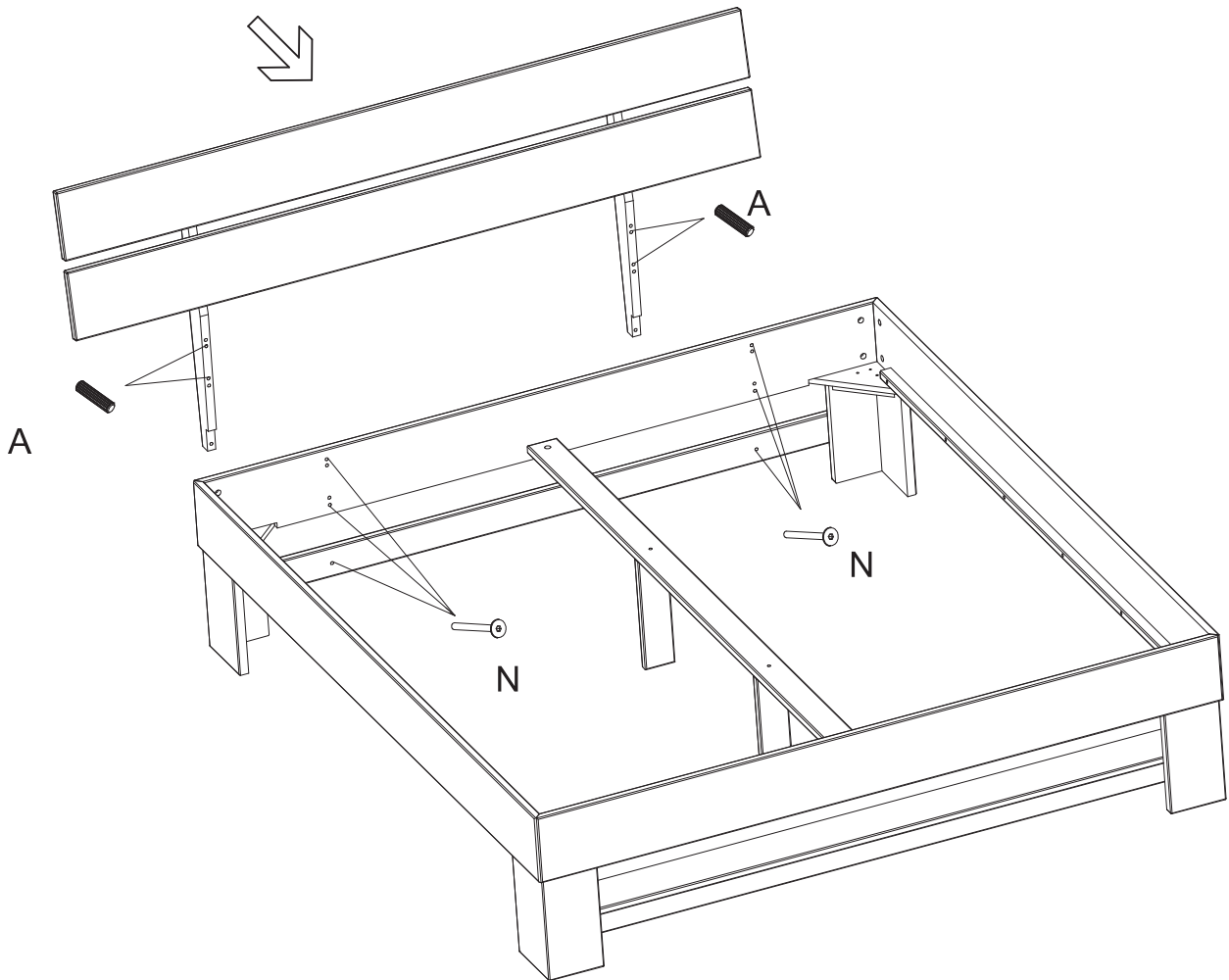

| | |
|---|---|
| A | H |
|  |  |
| Ø 8x30 8 | Ø 4x40 8 |

VIII



| | |
|---|---|
| A | N |
|  |  |
| Ø 8x30 4 | M6x40 6 |