

980014

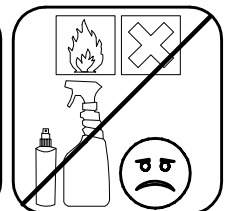

② 2x 231/1476 x 120 x 32

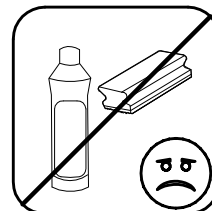
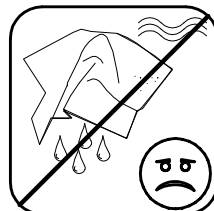
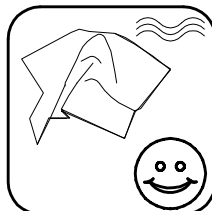
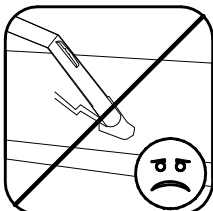
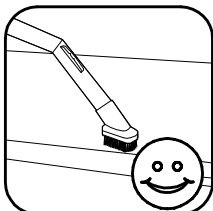
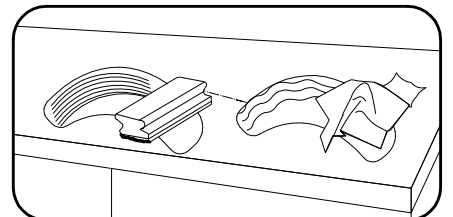
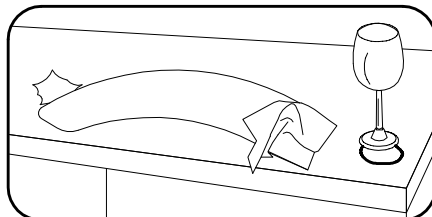
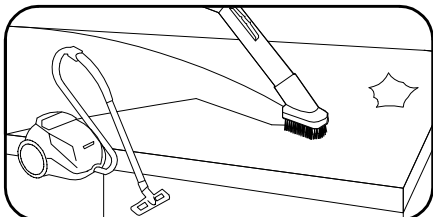
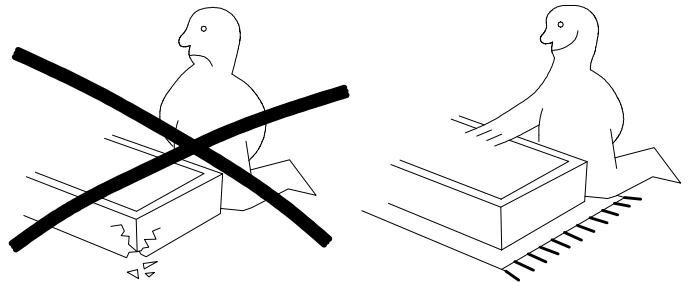
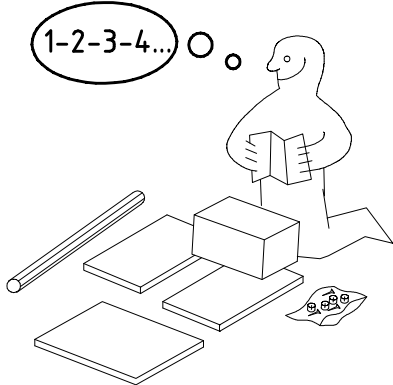
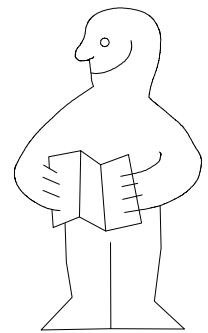
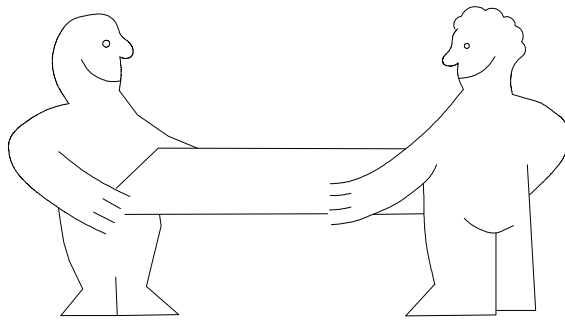
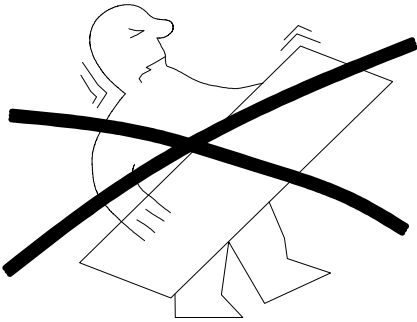
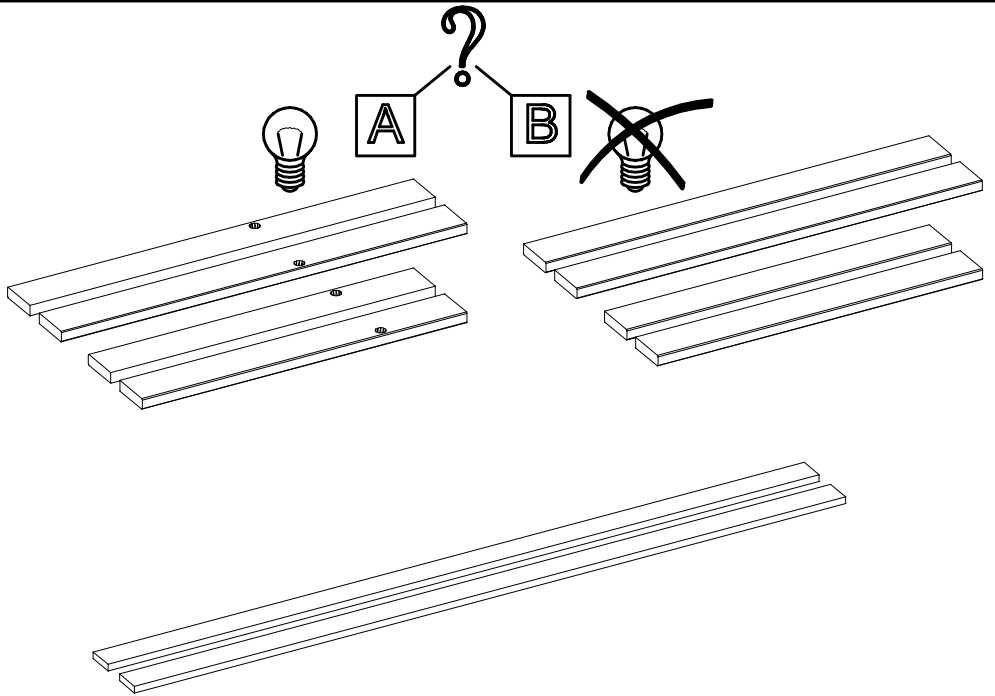
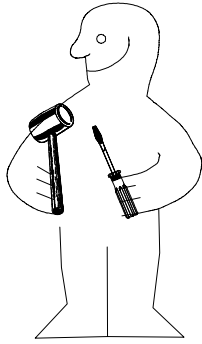
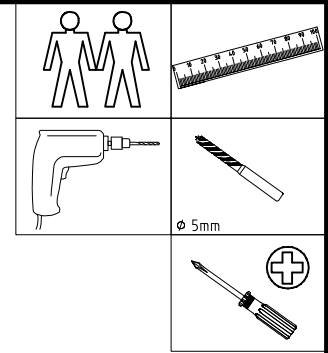

②B

②C

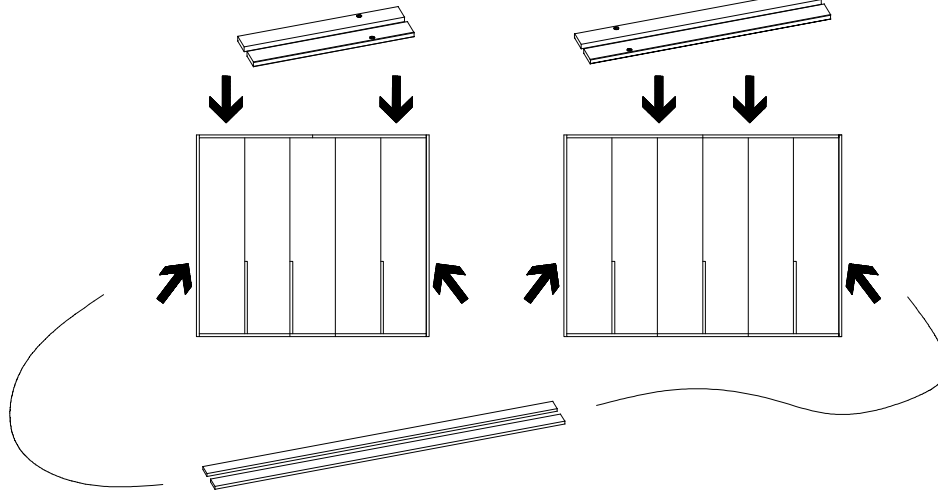

① 2x 2192 x 122 x 32

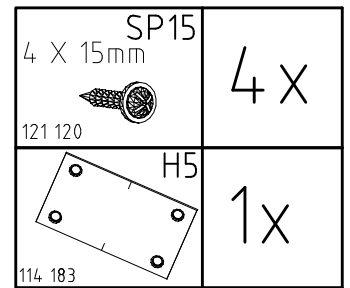
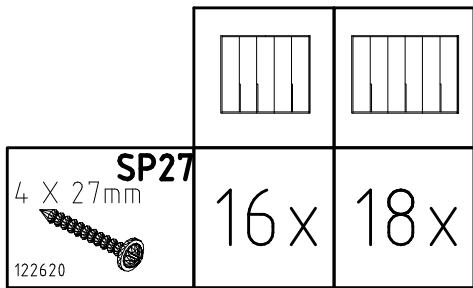

1

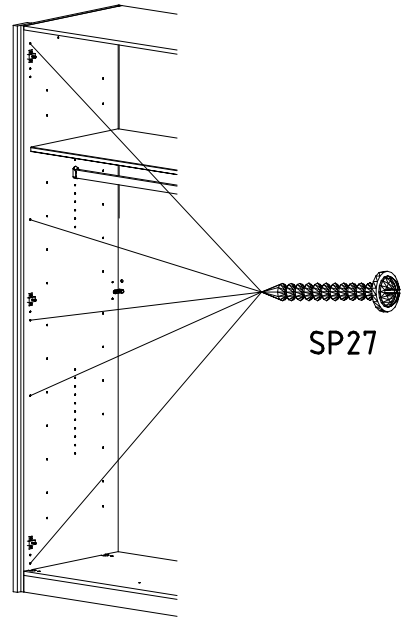
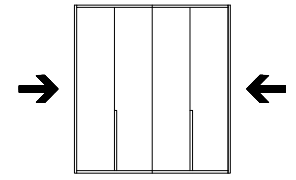
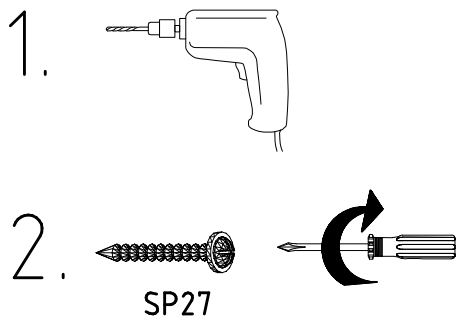
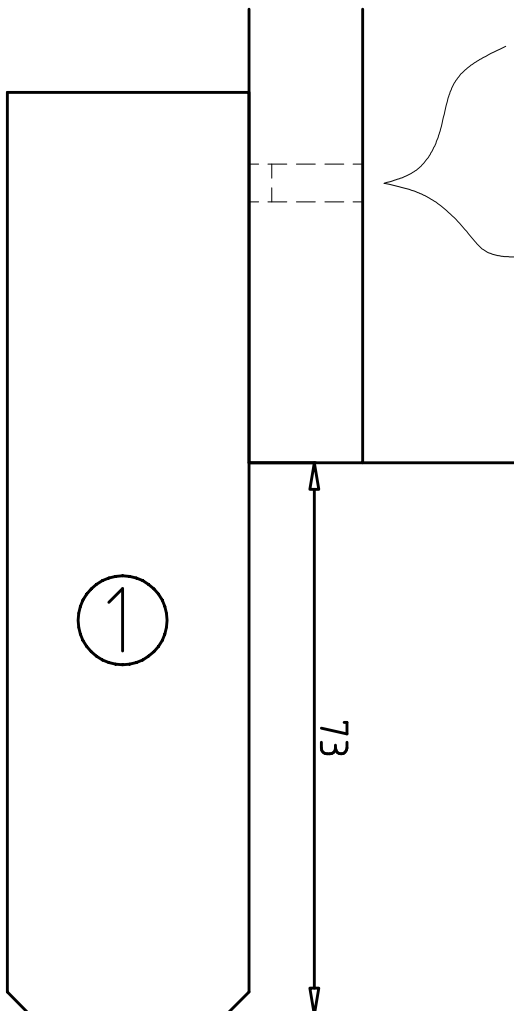

2

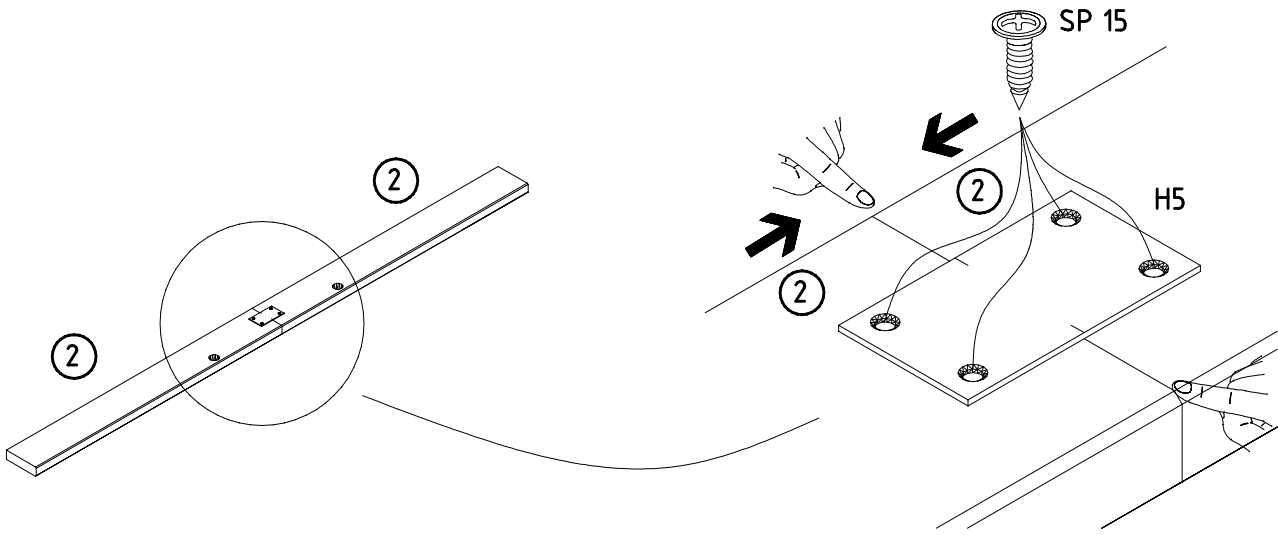

2B

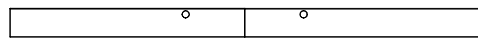

2C

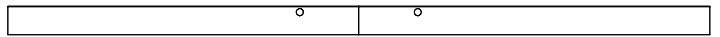

3

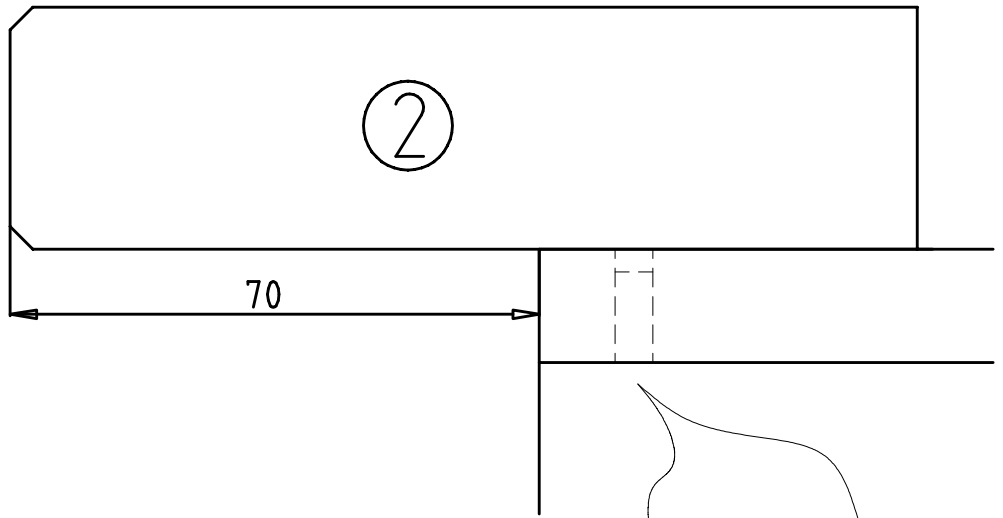

1.

2.

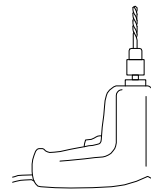

SP27

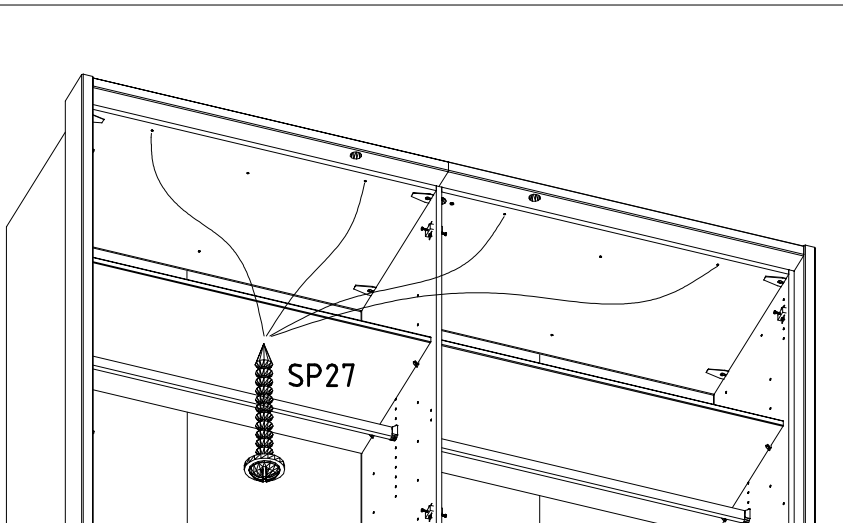
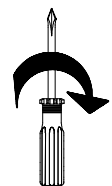

4

