

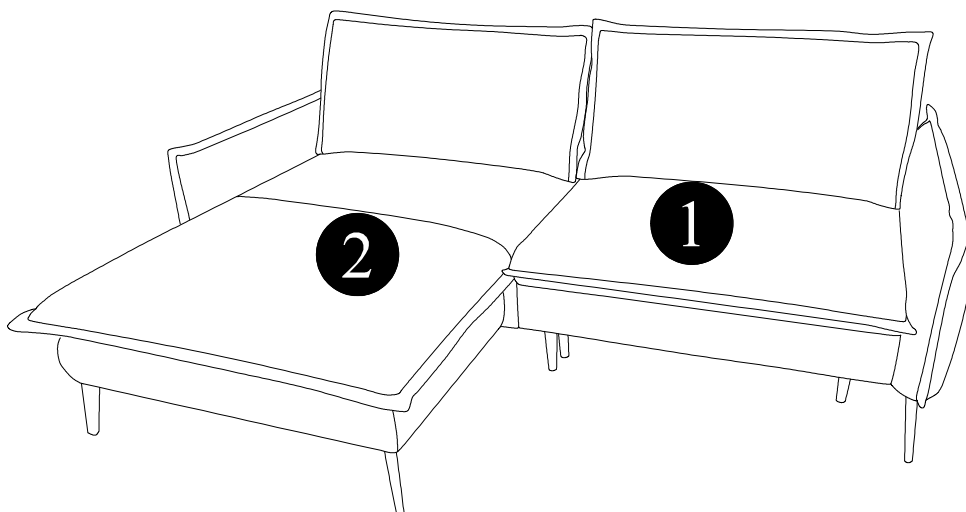

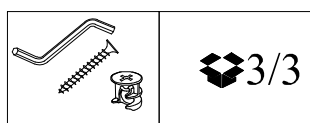

Teil	L	W	H	Pcs	Colli
①	105	112	56	1x	1/3
②	115	162	56	1x	2/3

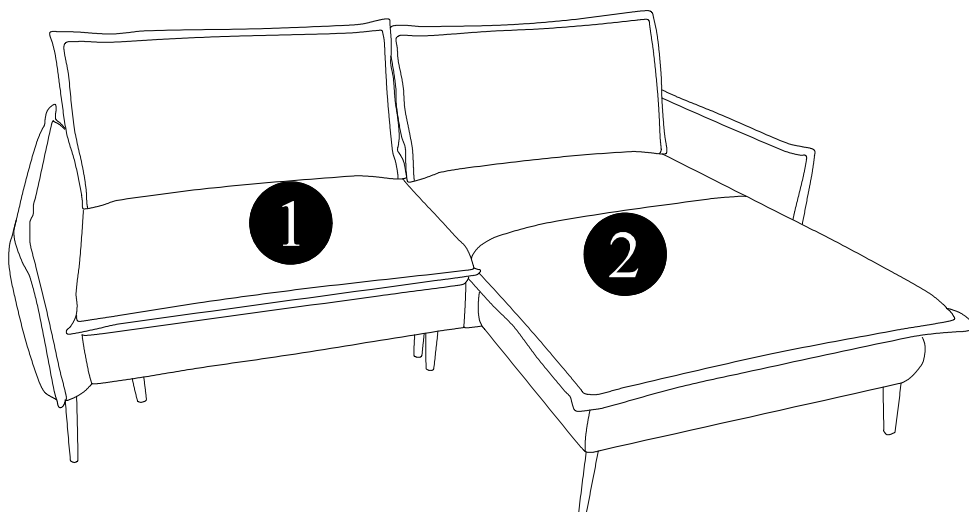

L



R



A	B	C
		
9x	4x	13x
H-170	H-130	ø 20

A	B	C
		
3x	4x	7x
H-170	H-130	ø 20

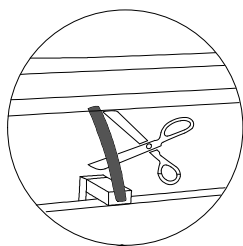

1

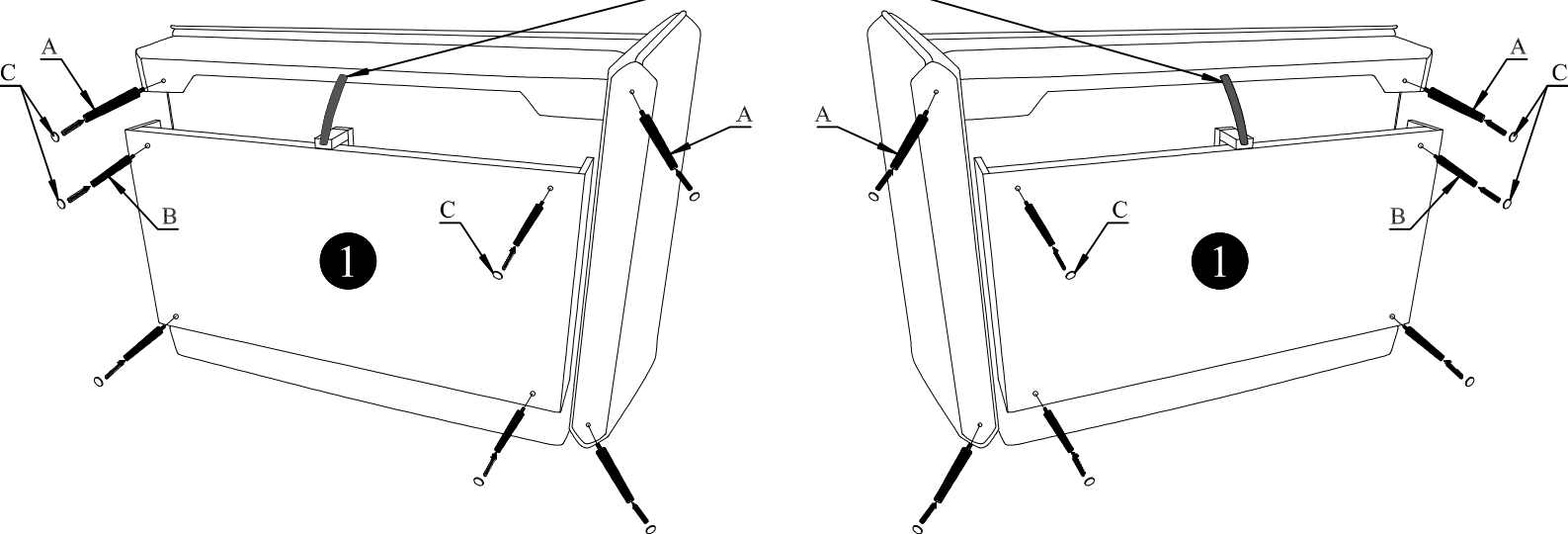

L

R



A	C
	
6x	6x
H-170	ø 20

2

L

R

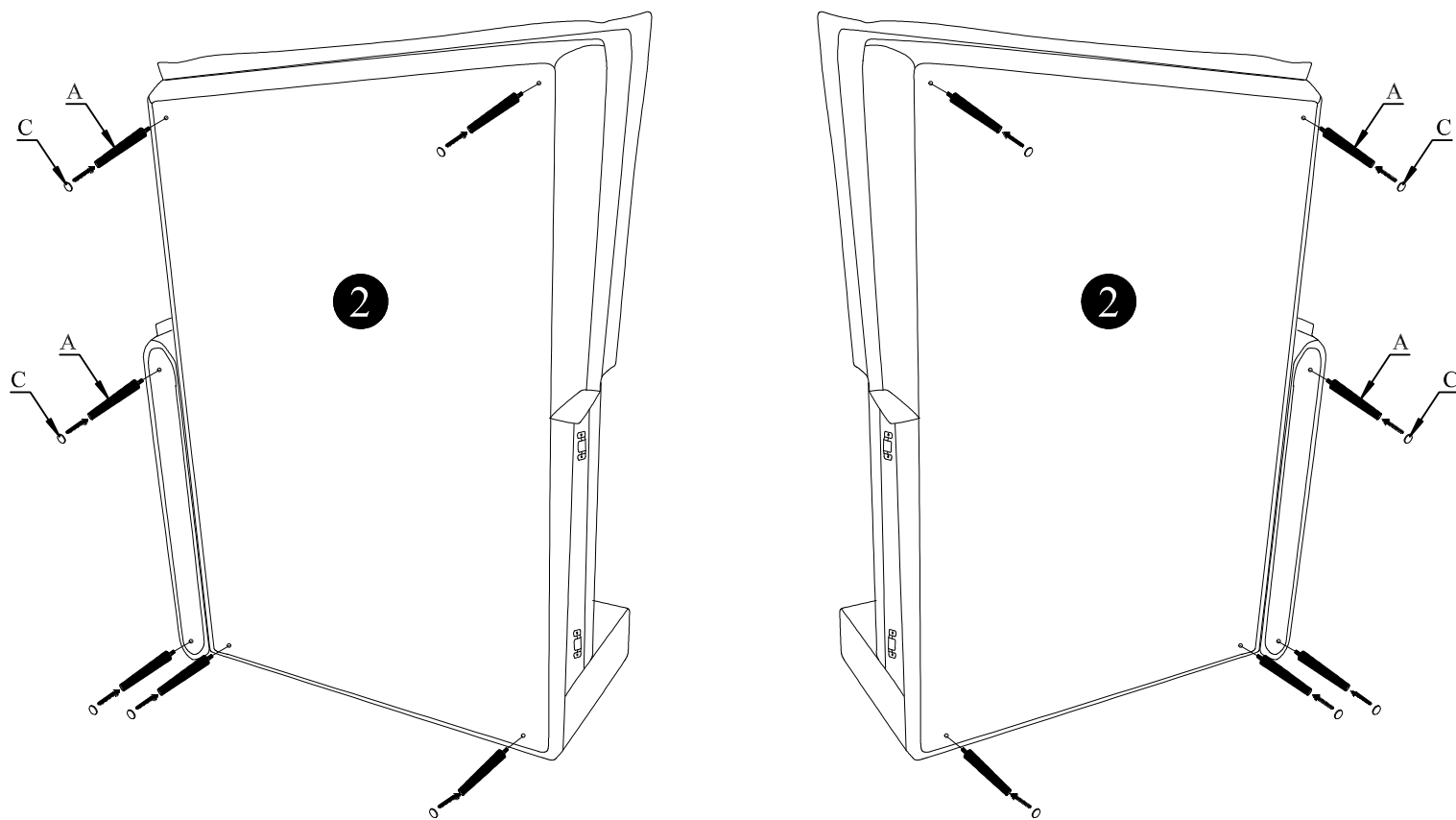

3

