

# “3515”

versionsnummer: 16.12.2023

Naturholz kann sich werkstoffbedingt verziehen. Durch das Montieren ziehen sich Teile wieder plan.

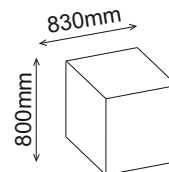
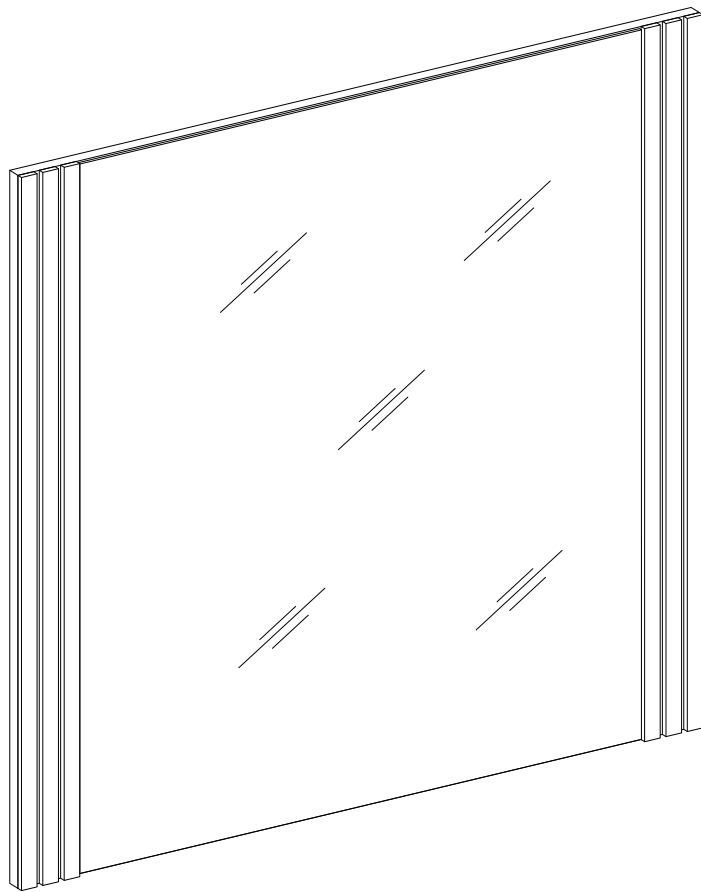
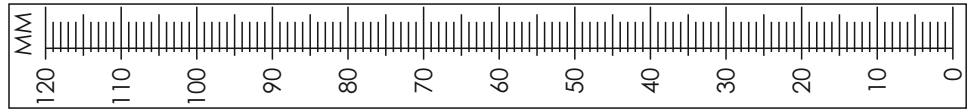

## B1

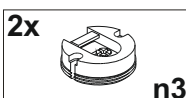
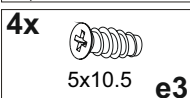
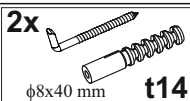

**1**

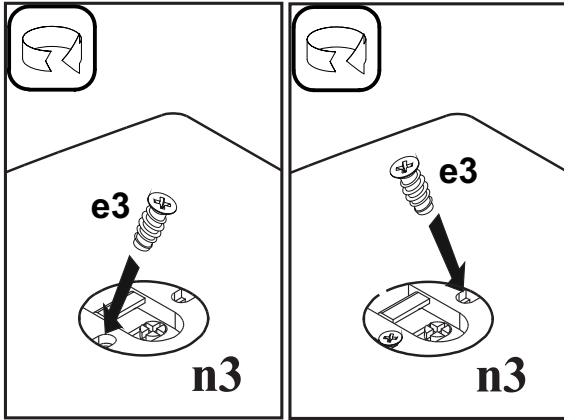

4x  
5x10.5 e3

2x  
n3

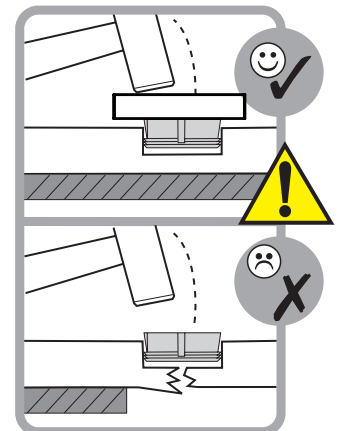
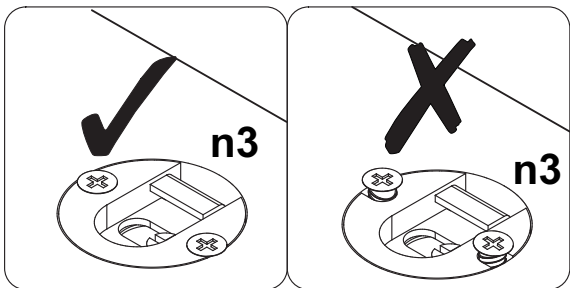
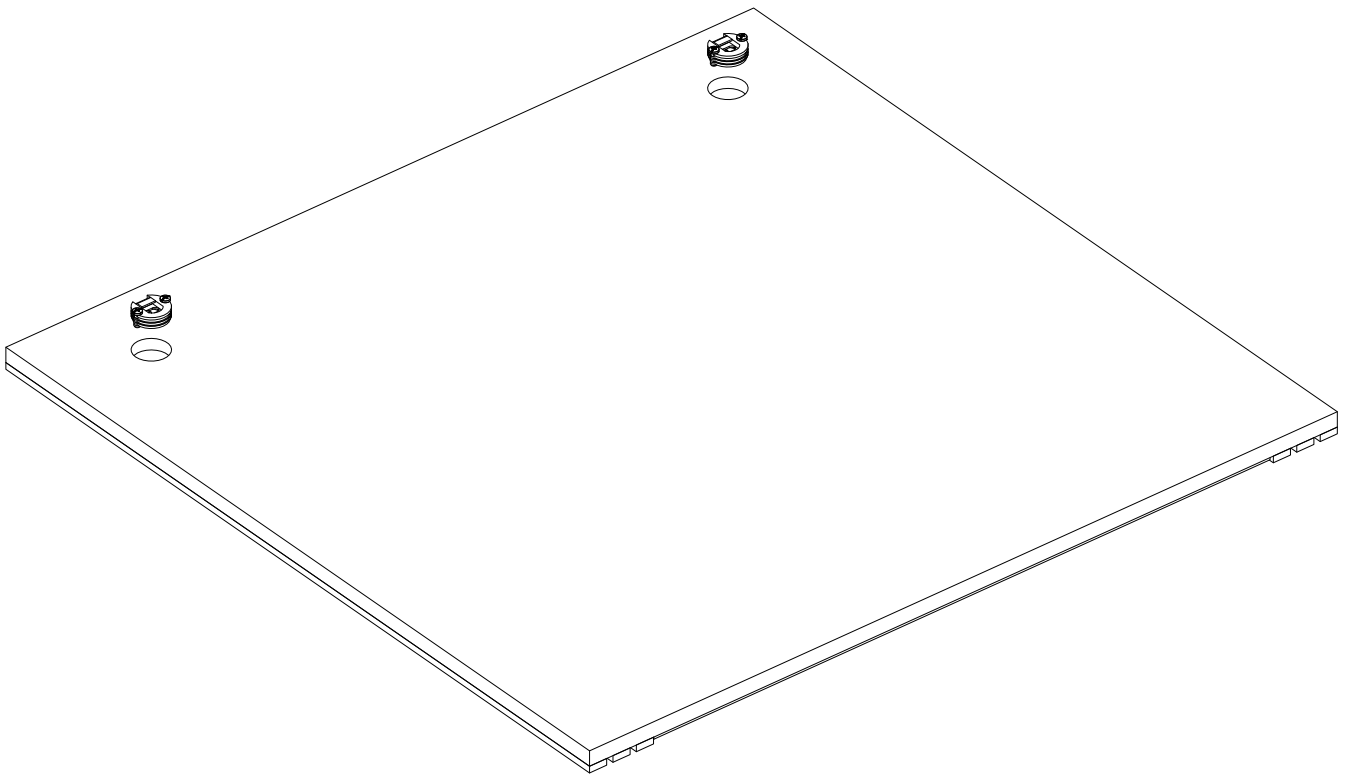

**2**

**2**

x2  
φ8x40 mm t14

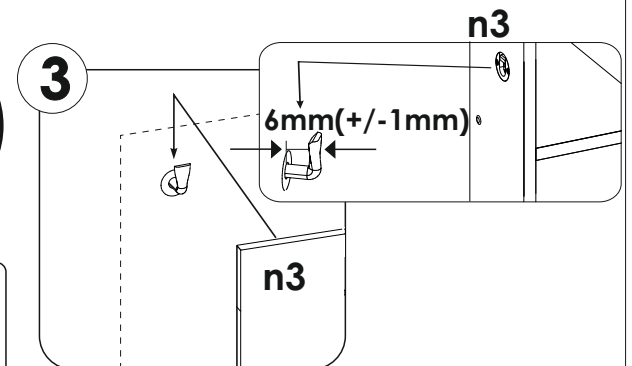
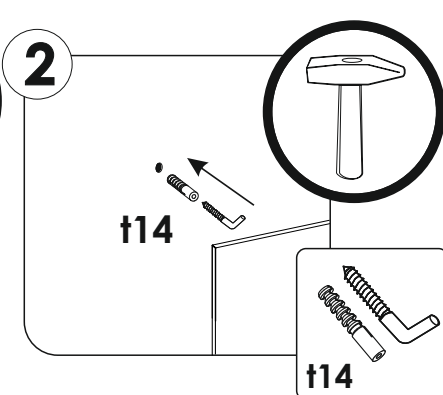
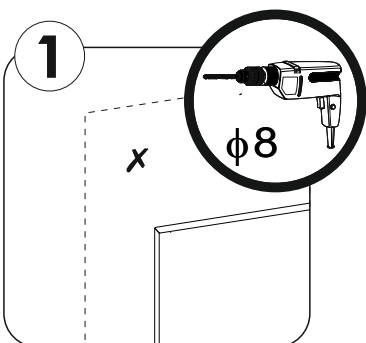
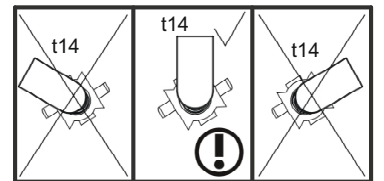
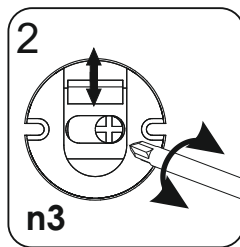
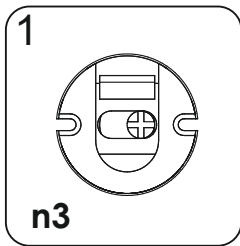
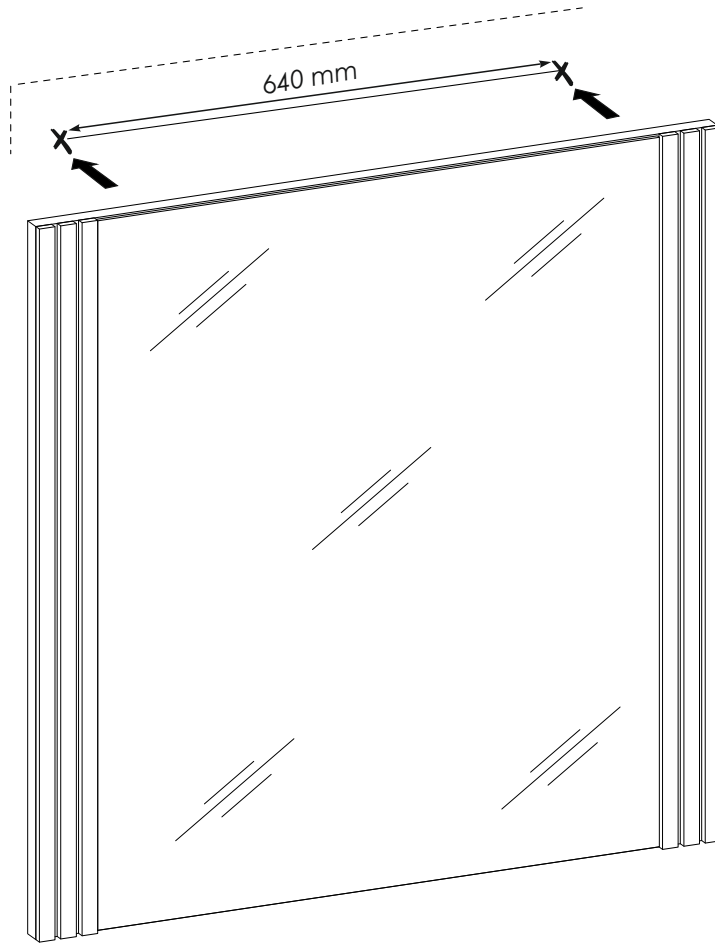
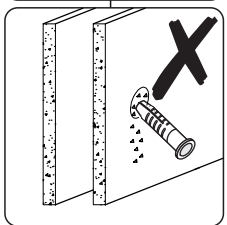
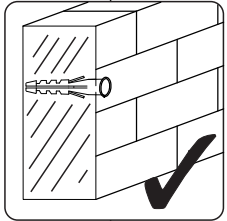
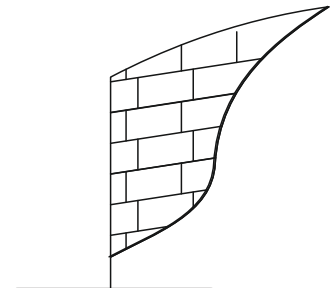

**3**